

ADELAIDE FRETWORK



---

UNIT 2, 14A FOLLETT CLOSE, LITTLEHAMPTON SA 5250  
TEL: 08 8391 3586 • FAX: 08 8391 3186  
EMAIL: [info@adelaidefretwork.com.au](mailto:info@adelaidefretwork.com.au)

---



ADELAIDE FRETWORK



Adelaide Fretwork—  
for a  
fabulous  
range of  
fretwork designs



ADELAIDE FRETWORK



# ADELAIDE FRETWORK



---

UNIT 2, 14A FOLLETT CLOSE, LITTLEHAMPTON SA 5250  
TEL: 08 8391 3586 • FAX: 08 8391 3186  
EMAIL: [info@adelaidefretwork.com.au](mailto:info@adelaidefretwork.com.au)

---



# contents

About us	3
<b>Exterior designs</b>	
–verandah brackets	5
–screen doors & brackets	11
–gable inserts	13
–gable vents	15
–window canopies	17
–fascia and barge trims	19
–mouldings	21
–miscellaneous	23
<b>Interior designs</b>	
–hall arches	25
–room dividers	28
–miscellaneous	30
–motifs	31
–mouldings	31
<b>Builders</b>	
–curved bath hobs	33
–bressumers	33
–curved bulkheads	34
–gables	34
–portico and arch templates	34





# About us

Adelaide Fretwork design and manufacture a comprehensive of fretwork. Since inception over 18 years ago, the company has helped both heritage home owners and builders around Australia restore homes to the period or add character to a new home through the use of decorative fretwork.

It's our belief that heritage homes appear "naked" without decorative fretwork.

Our extensive range of designs includes fretwork gables, brackets, motifs, screen doors, window canopies, exterior and interior friezes, room dividers, hall arches and internal grilles.

Importantly, we can custom manufacture to your exact specifications and recreate any design your require, including hard to find heritage pieces.

Adelaide Fretwork prefer and recommend the use of Western Red Cedar or external grade plywood – timbers which can withstand the elements over decades when treated correctly.







Sophisticated CNC machinery and hand operated fretsaws are used to manufacture our products. We can provide rapid response to your orders and consistent quality is assured.

The team at Adelaide Fretwork look forward to receiving your enquiry and helping you with your project.

## Exterior Fretwork

Adelaide Fretwork can supply or design exterior fretwork that complements both new and heritage homes.

For existing homes, we can supply authentic fretwork that's true to the period or custom-create to specification.

Exterior fretwork includes:

- » gables
- » inserts
- » brackets
- » motifs
- » screen doors
- » window canopies
- » exterior friezes.



# exterior -verandah brackets designs



*Doves*



*Koala*





*Kooka*



*Cockatoo*



*The Gums*

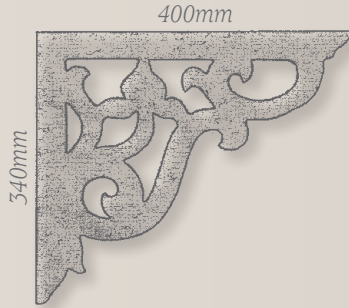

*The Spade*

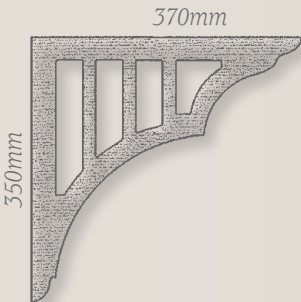

*The Classic*

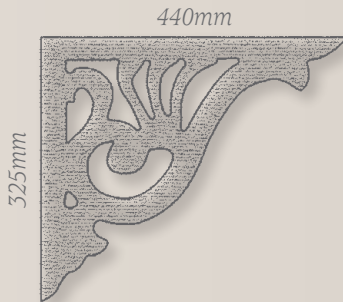

*Lyre*





# Exterior Designs – Verandah Brackets

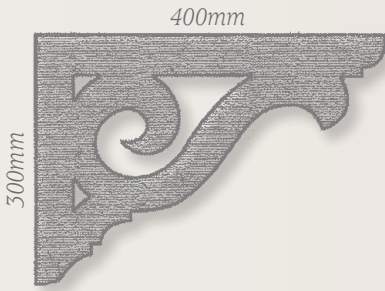

**AF8**

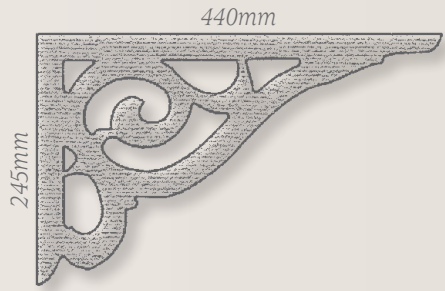

**Canterbury**

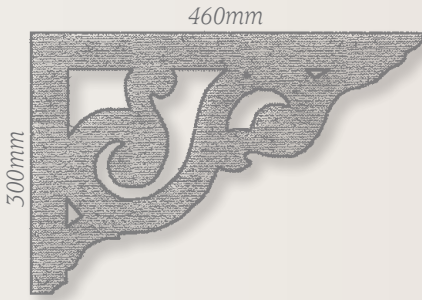

**AF9**

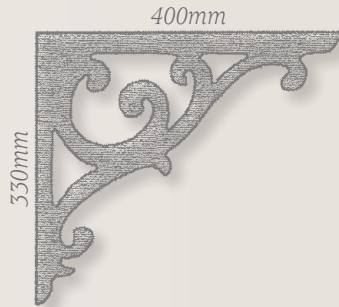

**AF10**

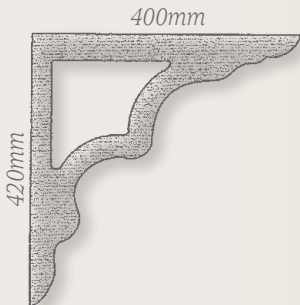

**Burke's**

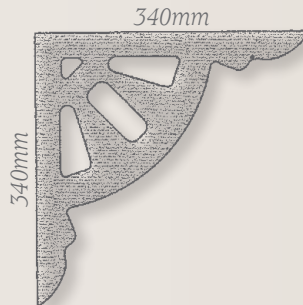

**The Alexander**



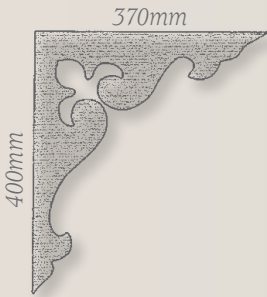

*Fleur De Lys*

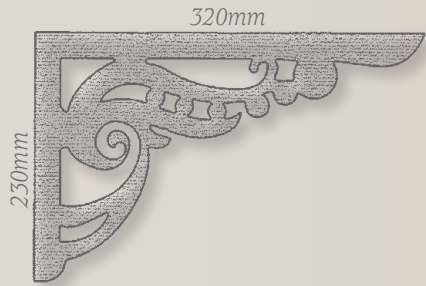

*Waves*

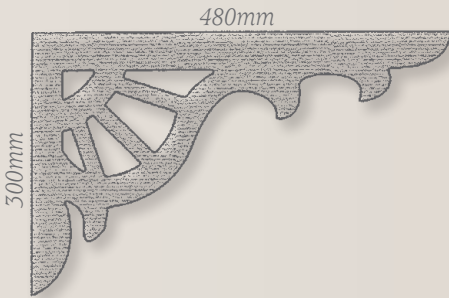

*Federation*

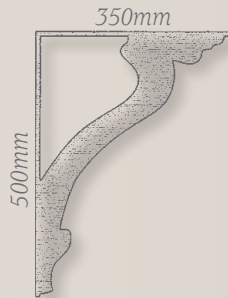

*Baroque*

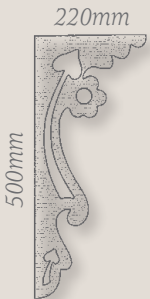

*Nouveau*

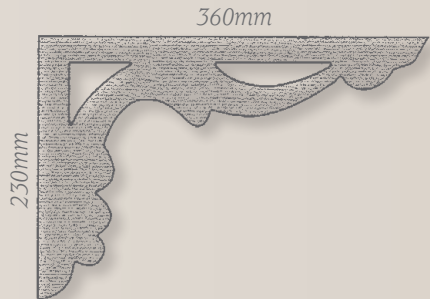

*The Ascot*



# Exterior Designs – Verandah Brackets

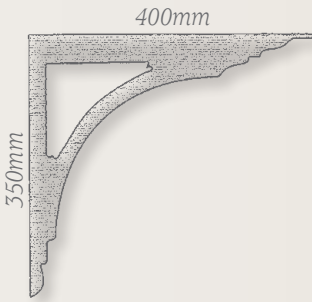

*Simplicity*

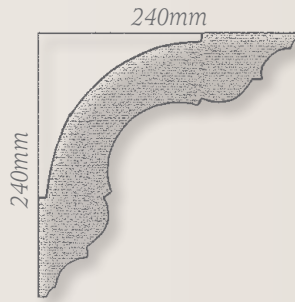

*No.1*

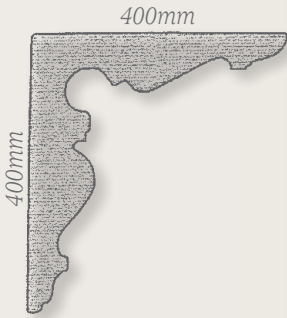

*No.2*

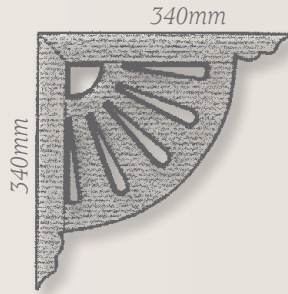

*No.3*



*AF1*

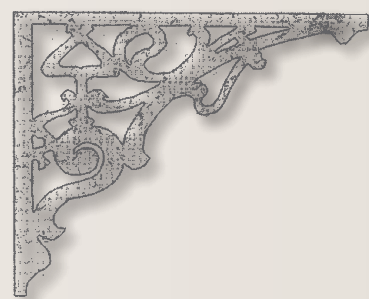

*AF2*



*We can custom manufacture  
to your exact specifications  
and recreate any design you  
require, including hard to find  
heritage pieces and replacement  
“one-offs”.*



# exterior designs

-screen doors & brackets

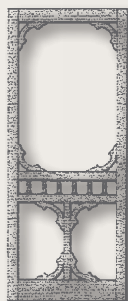

No. 1



No. 2





No. 3



No. 4



*Screen door brackets*

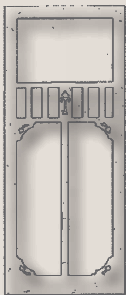

AF 13

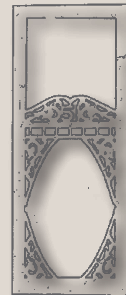

AF 14



# exterior designs

-gable inserts



1

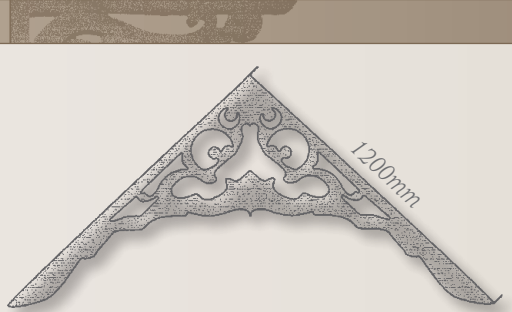

2



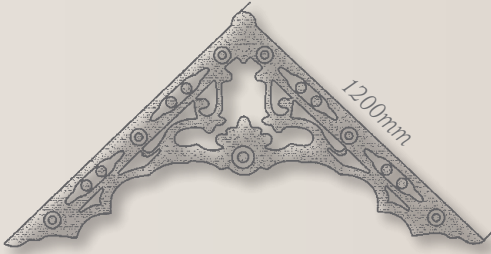

3

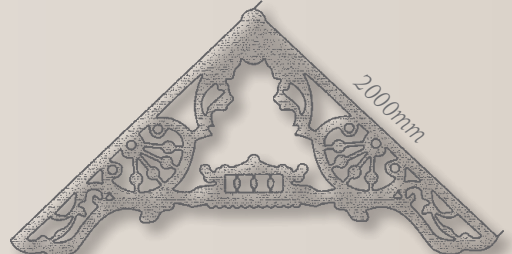

4

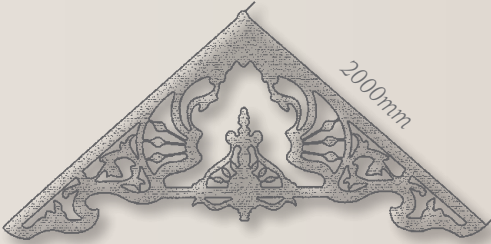

5

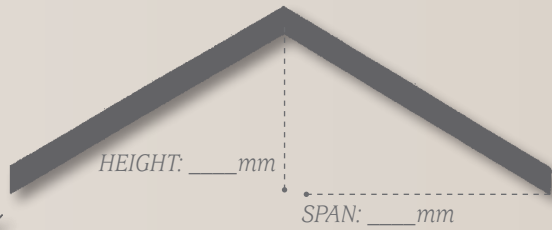

*Australian Classic Series*



AF5



AF6



# exterior designs

-gable vents

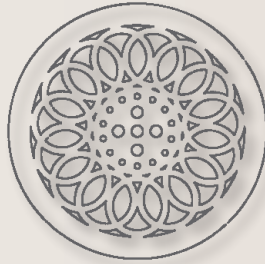
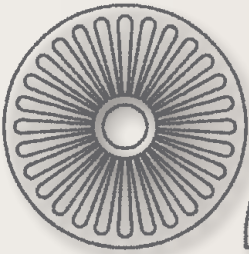

*Full/Half Sun Ray*

*Circle*



*Since inception over 18 years ago, the company has helped both heritage home owners and builders around Australia restore homes to the period or add character to a new home through the use of decorative fretwork.*





# exterior designs

-window canopies

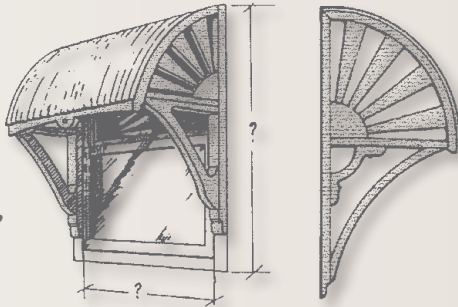

*When ordering,  
please specify  
window sizes.*

No. 1



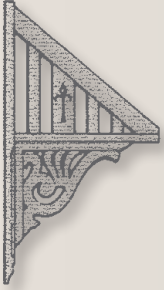

No. 2

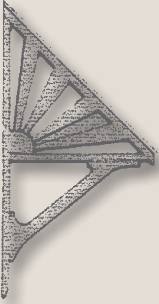
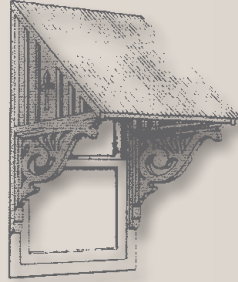

No. 3

*Window canopies may be altered to suit your design.*



# exterior designs

-fascia and barge trims

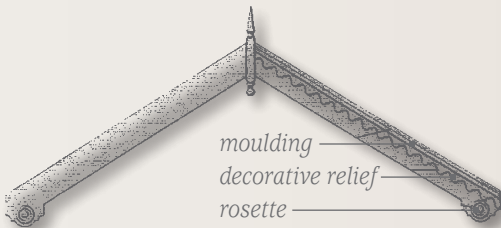

No. 1

No. 2



## Mouldings



*External Moulding 1*

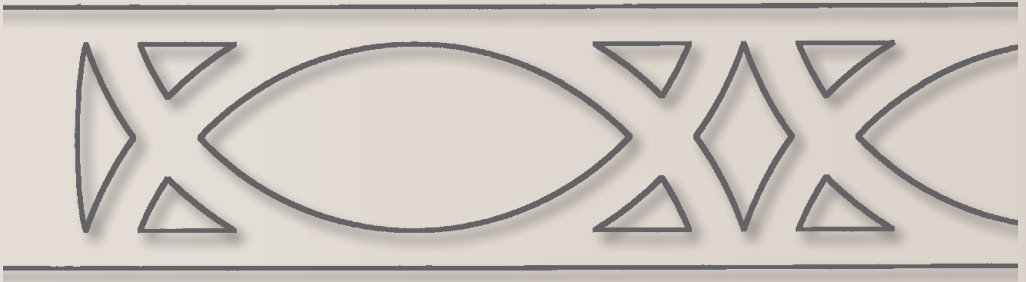

*External Moulding 2*



*External Moulding BORD 011*





*External Moulding AFB 02*



*External Moulding AFB 03*



*External Moulding FW 03*





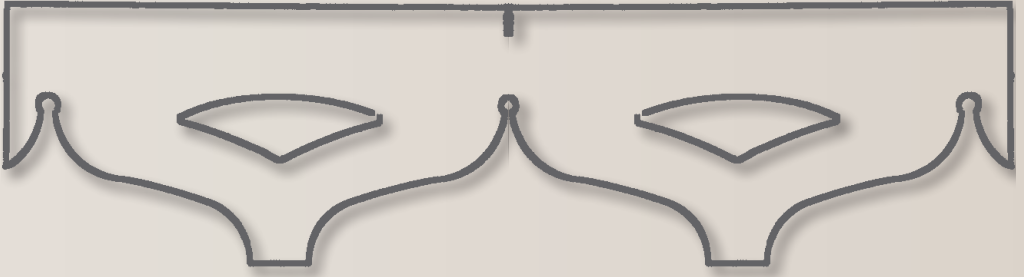

*External Moulding AFB 02*

*Adelaide Fretwork prefer and recommend the use of western red cedar and external grade plywood – timbers designed to withstand the elements over decades*



# exterior designs

-miscellaneous



*Eave bracket 1*

*Eave bracket 2*

Can be supplied with or without spindle.





*Exterior frieze 1*



*Exterior frieze 2*



*Handrail insert 1*



*Handrail insert 2*

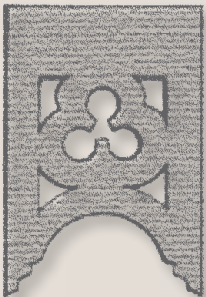

*Handrail insert 3*

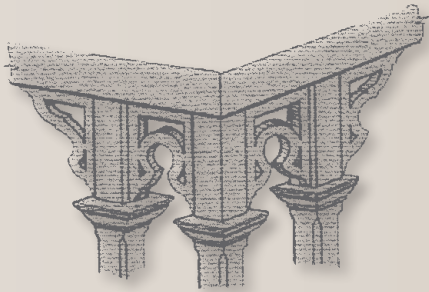

*Post inserts*



# interior designs

-hall arches

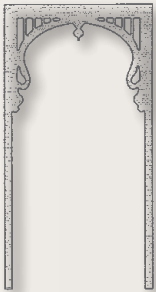

900mm

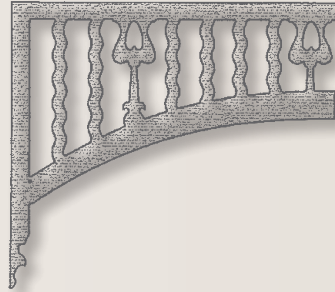
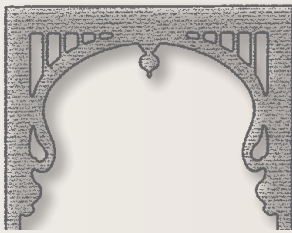

1

2



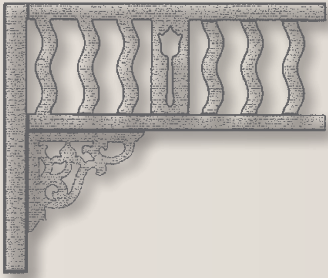

3

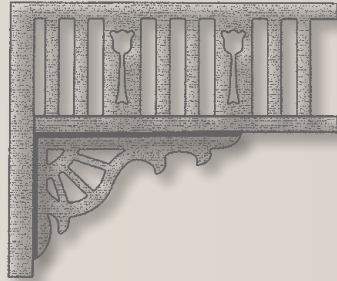

4



*Victoria*



*Victoria Floral*

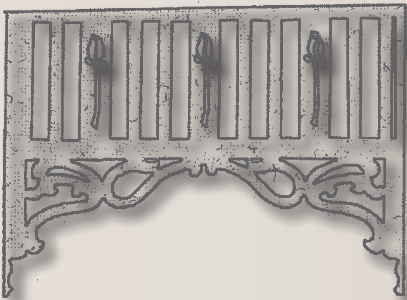

*AF 11*



*AF12*





# Interior Designs – Hall Arches

ADELAIDE FRETWORK



AF15



AF16

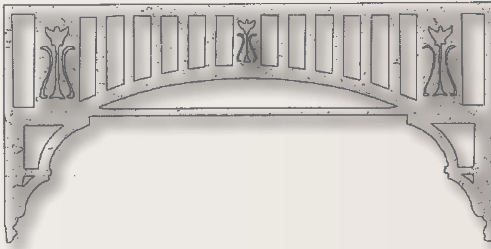

AF17



# interior designs

-room dividers



Suitable for passage or bay window

1



Suitable for all openings

2



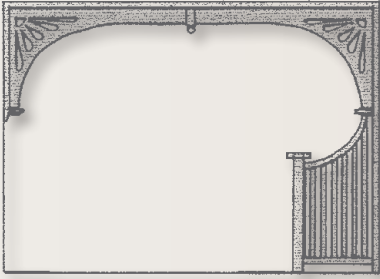

3

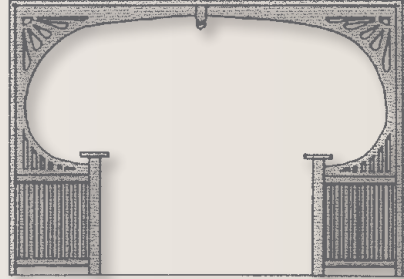

4

*Create a consistent character  
throughout your home with  
interior and exterior fretwork.*



# interior -miscellaneous designs

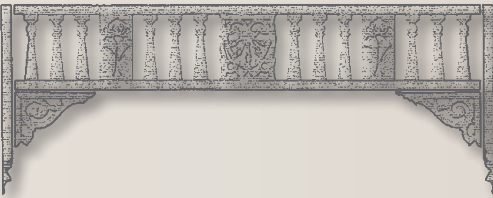

*Interior Frieze No.1*



*Interior Frieze No.2*



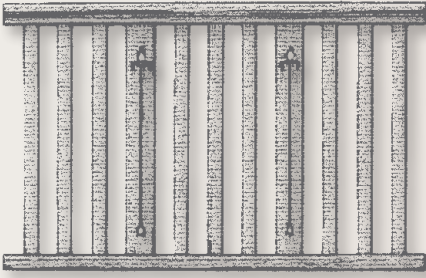

*Balustrading No.1*

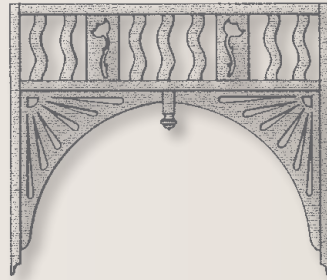

*Interior Grille – Sunburst*

## Motifs

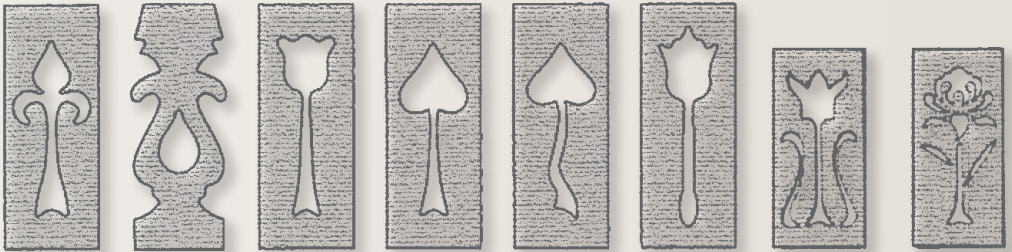

1 2 3 4 5 6 7 8

## Mouldings

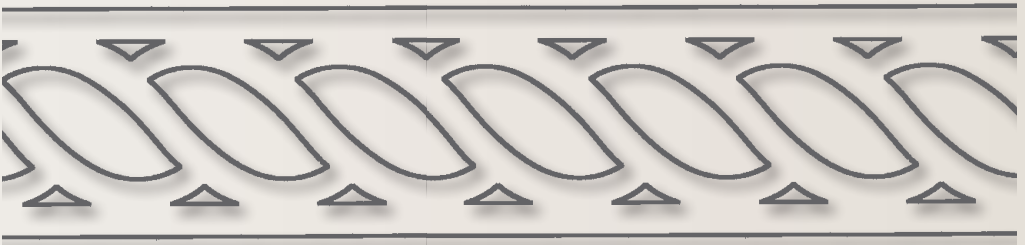

*Internal Moulding 1*





*Internal Moulding FW 08*

*For existing and heritage homes,  
we can supply authentic fretwork  
that is true to the period or  
custom-create your specifications.*





# builders

-miscellaneous items



*Bath & Step Hob*



*Bressumer*



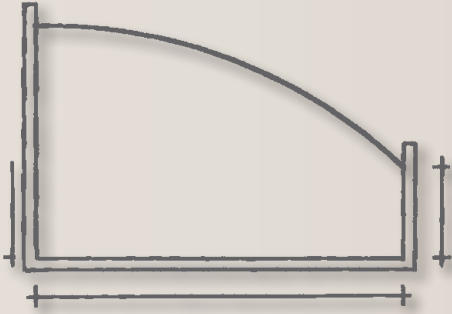

*Curved bulkhead*

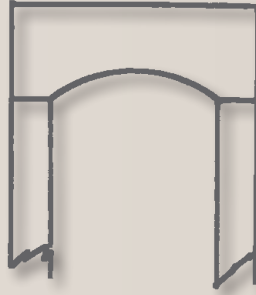

*Portico*

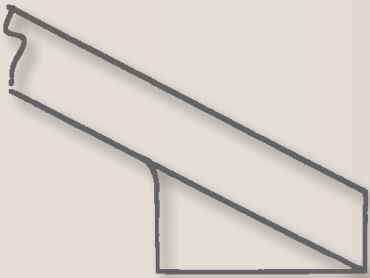

*Barge Heel*

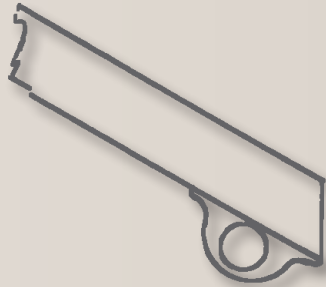

*Barge Heel with Rosette*

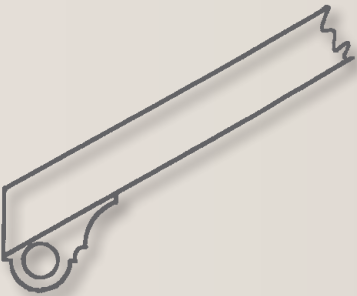

*Barge Heel with Rosette*

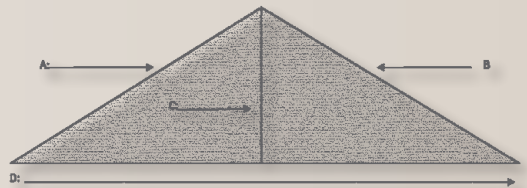

*Gable*

